

The World of Posi Technology

THE POSI-STRUT™ TECHNICAL HANDBOOK

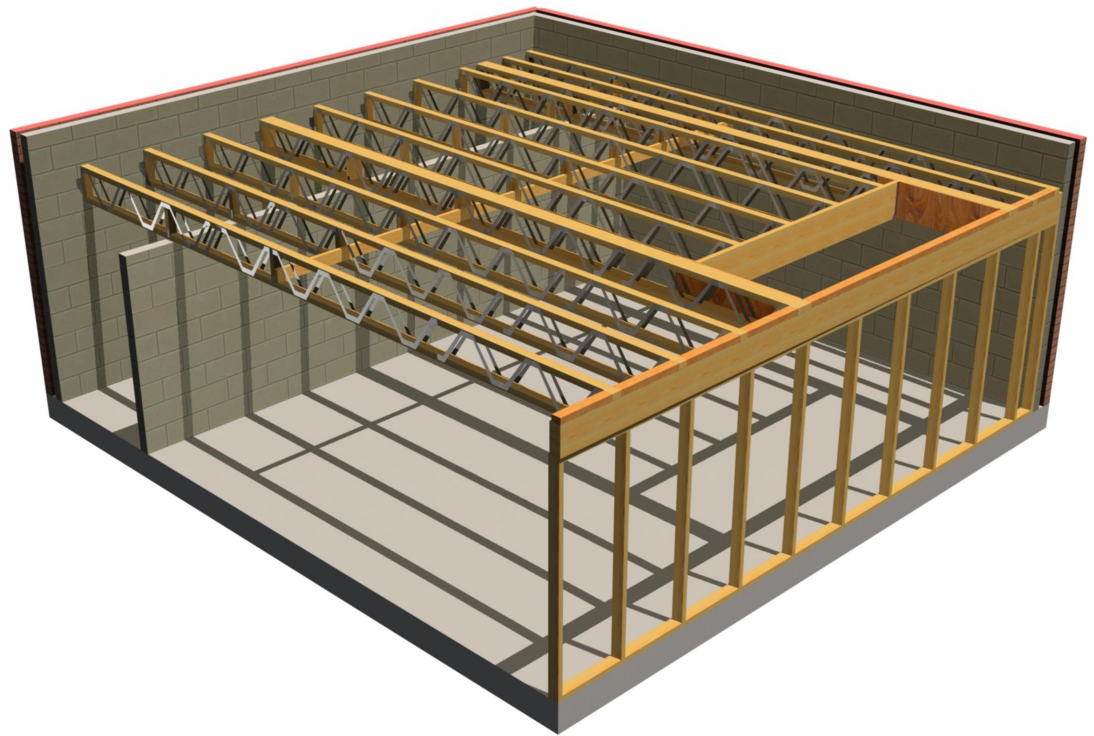

CONTENTS

Posi-Joist Flooring

[An Introduction to Posi-Joists™](#)

[Ground Floor Applications](#)

[Intermediate Floor Applications](#)

[Separating Floor Applications](#)

[Standard Details](#)

[Span Information](#)

[Site Handling and Storage](#)

Roof Applications

[Posi-Rafter Standard Details](#)

[The X-Rafter](#)

[Posi-Attic trusses](#)

Wall Applications

[The Posi-Stud](#)

[Sample construction details](#)



Introducing Posi-Joist™



Available in Six Standard Depths

PS8	202mm	PS14N	373mm
PS9N	225mm	PS16N	421mm
PS10N	253mm		
PS12N	304mm		

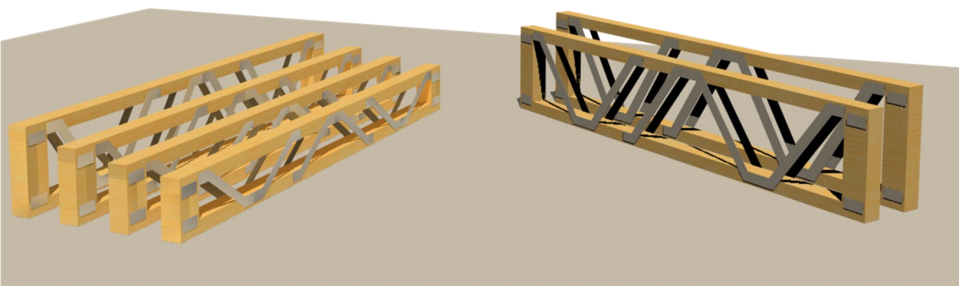

Posi-Joist™ is a tested product with a European Technical Approval ETA-07/0161. Fire tests of 30, 60 and 90 minutes have been successfully passed. Acoustic tests for impact and airborne sound transfer have also been successfully passed. See Page 10 for more details.

You simply can't afford to ignore the advantages of the Posi-Joist™ system.

To start with, because Posi-Joist™ combines the lightness of timber with the strength of the Posi-Strut™ steel web, you can span far greater distances than would be possible with alternative timber products.

This gives you unequalled design freedom across a wide range of applications for both floor and roof in domestic, industrial and commercial applications. The Posi-Joist™ allows a variety of internal room layouts within an external shell due to its clear spanning capabilities.

THE ALTERNATIVE JOIST SYSTEM

ECONOMY



Exceptional floor performance from a minimum 72mm wide fixing surface makes flooring easy, controls shrinkage and with precision engineering it all reduces those tiresome return visits and remedial work.

More benefits such as the unique open web design provide an area in which Plumbers and Electricians will find it easy and convenient to work. The job's done far more quickly and the contractor makes worthwhile savings.

There when you need it ... Posi-Joists™ Trimmable End provides field cutting flexibility!



The Posi-Joist™ ability to span greater distances than its timber competitors and the fact that they are fully competitive with steel and concrete beams makes it immediately obvious that they offer considerable savings in raw materials. The open web design gives the contractor another important advantage: it makes installation of service and utilities far simpler and quicker, reducing both labour costs and build-up time on site.

What's more, since they eliminate the need for load-bearing intermediate walls they dramatically cut overall building costs.

Quite simply, there's no more efficient or economical way to construct floors and roofs.

Even on long spans, no herring bone strutting is necessary with the Posi-Joist™ system. If the span exceeds 4m a strong-back is installed at mid-span.

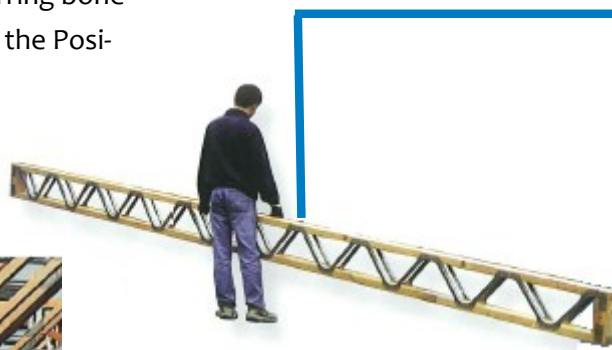
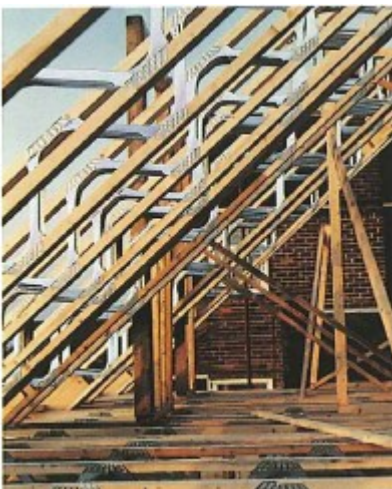

The Posi-Joist™ can adequately span for flat and pitched roofs.

Its span capability and timber flanges make it the more desirable alternative to all steel systems.

FLEXIBILITY IN USE

Design flexibility is inherent in the concept of the Posi-Joist™. The depth length and specification can be adjusted to produce an enormous number of different specifications, each with clearly defined performance criteria. In addition, end details of the beam can be altered to give a variety of support conditions.

You will never come up short with the Posi-Joist™ Trimmable End. Each end can incorporate a solid timber block which can be engineered with up to 130mm allowance for trimming on site.

EFFICIENCY

MATERIAL SAVINGS

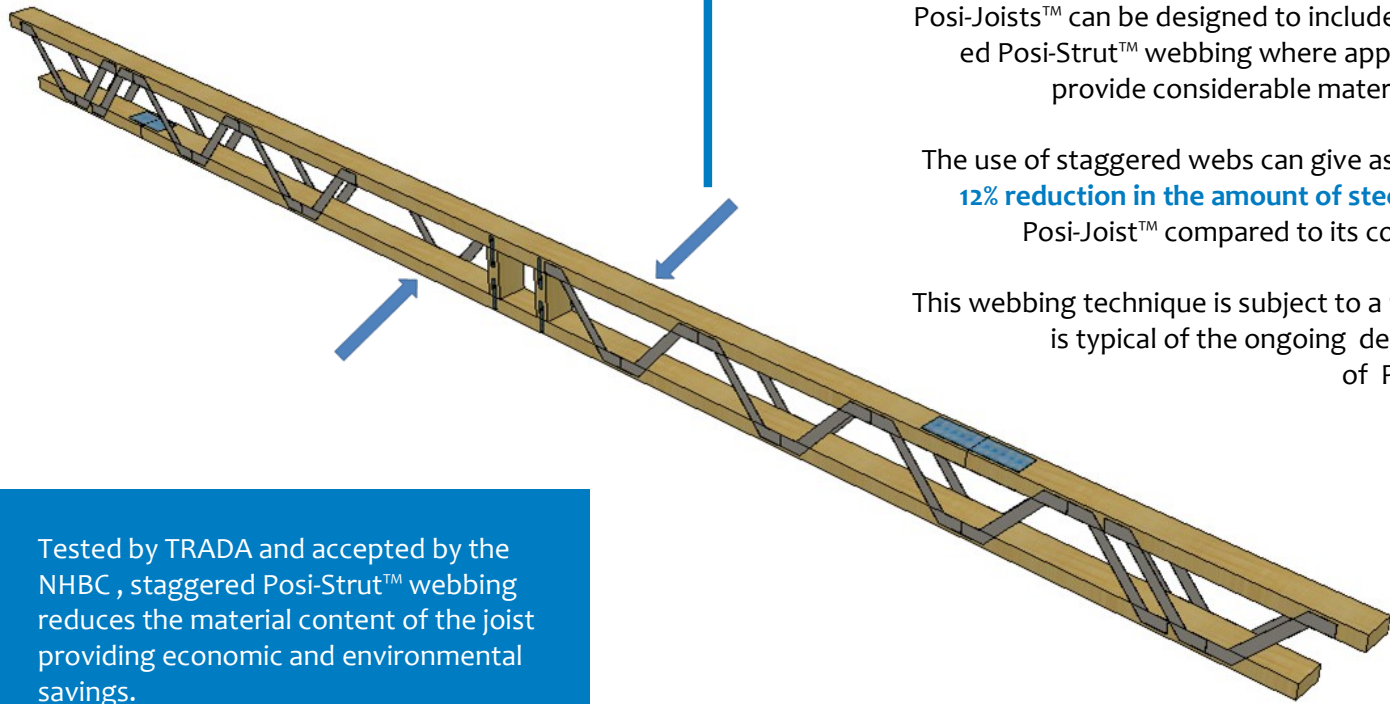

Posi-Joists™ can be designed to include single sided Posi-Strut™ webbing where appropriate to provide considerable material savings.

The use of staggered webs can give as much as a **12% reduction in the amount of steel** used in a Posi-Joist™ compared to its competitors.

This webbing technique is subject to a patent and is typical of the ongoing development of Posi-Joist™.

Tested by TRADA and accepted by the NHBC, staggered Posi-Strut™ webbing reduces the material content of the joist providing economic and environmental savings.

TRIM-IT™ VARIATION

The Trim-It™ end detail provides a flexible end detail perfect for applications with varying and uncertain spans. Trimmed on site prior to installation—up to 600mm can be removed per Posi-Joist™.



Maximum 600mm can be trimmed from a stock length

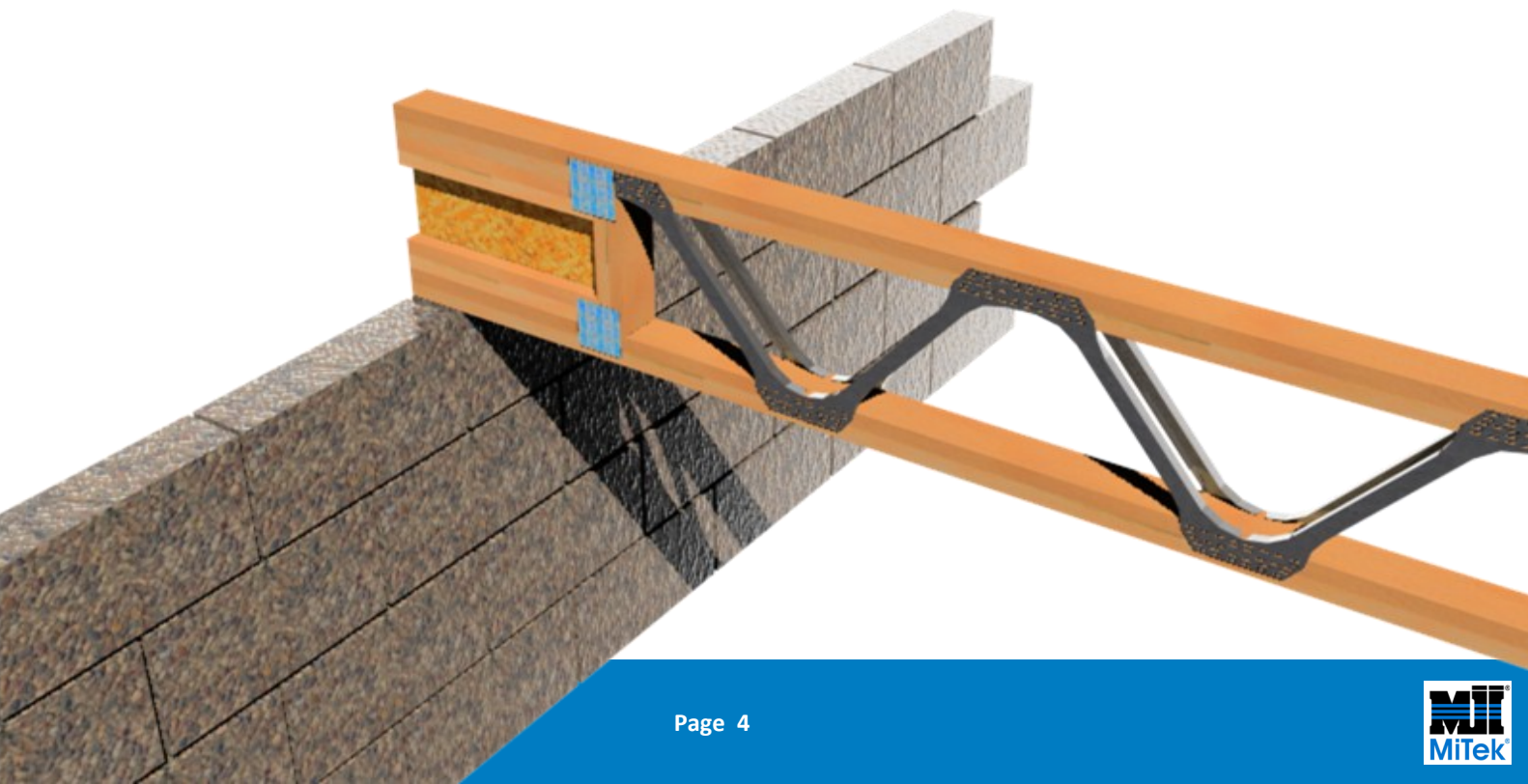

The World of Posi Technology

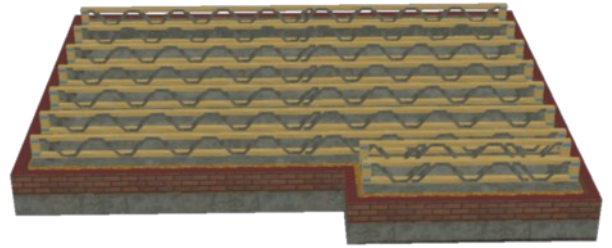

Ground Floor Applications

Ground Floor Applications

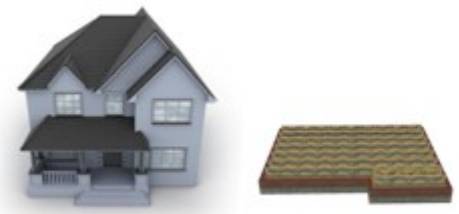

When designing Posi-Joists™ for use in suspended ground floors the following ground floor specific points should be considered

- 1—Since there is no ceiling attached to the underside of the Posi-Joists™, the bottom flange will not have any lateral restraint. Therefore, multiple spans should either be avoided, or restraint noggins should be inserted at bottom flange level on each side of internal supports where the lower flange is likely to be in compression.
- 2—The absence of a ceiling will result in a ground floor feeling less stiff when compared with other floors of the same joist depth and span. Additionally the kitchen/utility areas containing large kitchen appliances that produce dynamic movement are likely to be located on the ground floor. It may be appropriate to consider specifying more stringent deflection limits than those normally applied. This should be discussed with the building designer early in the project cycle to control vibration performance.
- 3—When planning the arrangement of Posi-Joists™ for suspended ground floors consideration should be given where practical to making the joists discontinuous between kitchen/utility areas supporting large kitchen appliances and living/dining areas, so as to minimise the occurrence of appliance induced vibration in living areas.
- 4—The environment within a suspended ground floor is classified as Service Class 2 and hence the deflection characteristics of the Posi-Joists™ may be different than for intermediate floors. Provided the void beneath the floor is well ventilated and drained and the ground cover layer inert the floor will perform as expected.
- 5—Joists in suspended ground floor applications need particular attention to construction detailing with regard to ground preparation, ventilation, insulation and disabled access.

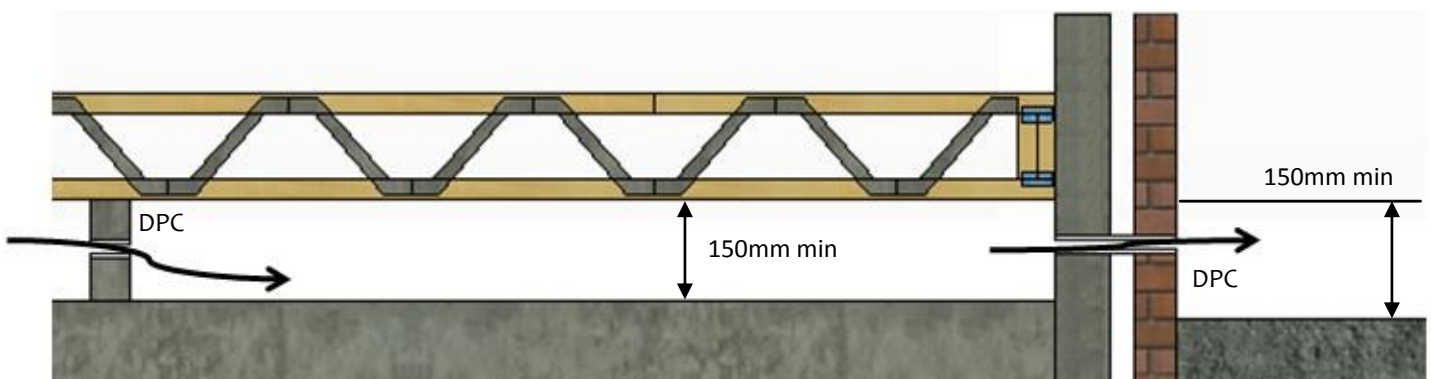

Notes to Diagram

The ground cover layer should be inert and resist the passage of moisture. One of the following constructions may be used, although other options may also be suitable:

- i) 50mm of inert sand, gravel or concrete on 300 micron (1200g) polythene (1000g if PIFA branded) lapped and turned at the edges, on 25mm sand blinding;
- ii) 100mm concrete on well consolidated hardcore;
- iii) 50mm concrete on polythene membrane on 50mm sand blinding.

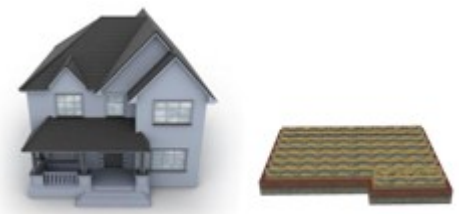

Notes to Diagram (Continued)

On sites where external ground levels are higher than internal, the internal ground cover should fall to a suitable drainage outlet.

Under floor ventilation should be in accordance with The Building Regulations and ventilator manufacturer specifications. Special care should be taken to ensure that adequate cross-ventilation is achieved. A minimum clear height of 150mm should be provided between the underside of the joists and the internal ground cover.

Where protection is required against Radon gas or other ground gases, specialist advice should be sought.

Insulation requirements will vary depending on the floor size and should be calculated by the Building Designer for each floor construction. Insulation can be installed in ground floor constructions by supporting the insulation between the Posi-Joists™ on either a rigid mesh, a breather membrane or fibre-board fixed between the joists.

The World of Posi Technology

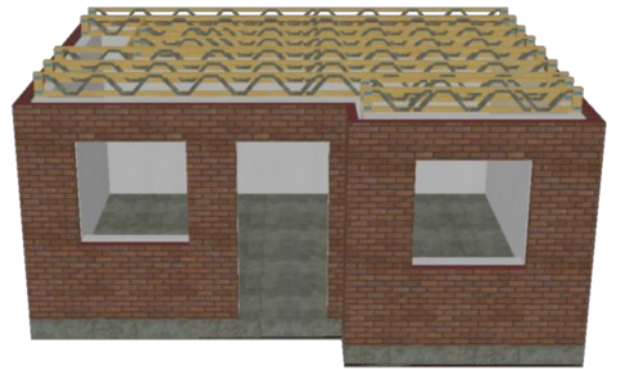

Intermediate Floor Applications



Intermediate Floor Applications



Typical Construction Details

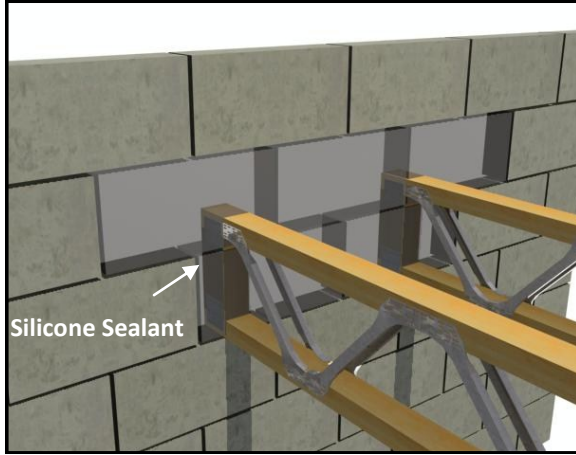

Block work to continue between Posi-Joists™ to provide restraint. Note: This is not allowed on solid external walls

Posi-Joists™ can be built into the inner leaf of an external cavity wall as illustrated. This method of construction meets the thermal and air leakage requirements of Building Regulations Approved Document L1 & L2 (2006) provided that the perimeter of the Posi-Joist™ is sealed with silicone sealant as shown and the wall is insulated to the Building Designer's specification. Alternative proprietary built-in constructions may be used, such as joist 'end caps', provided that they have been shown by third party tests to meet or exceed the air leakage performance of the construction illustrated. The construction illustrated provides lateral restraint to the wall. *Note: Certain 'end caps' may not provide lateral restraint to the wall, and restraint straps may therefore be required.*

Posi-Joists™ can be supported in masonry hangers at an external masonry wall. This method of construction meets the thermal and air leakage requirements of Building Regulations Approved Document L1 & L2 (2006). This detail does not provide lateral restraint to the wall unless a restraint type hanger is used, if standard masonry hangers are used restraint straps will be required.

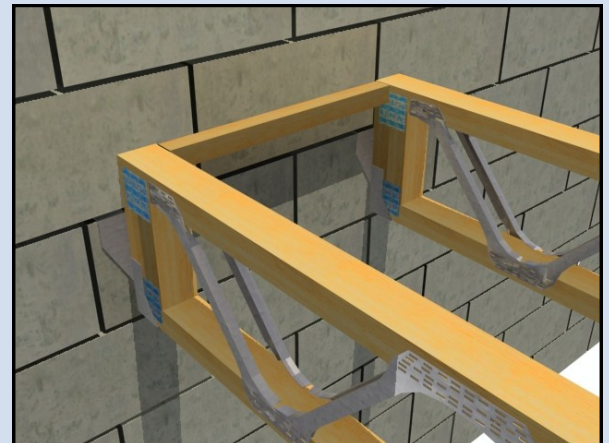

Top Chord restraint fixed between Posi-Joists™. (Choose correct hanger for load, bearing width and coursework level of hanger bearing flange.)

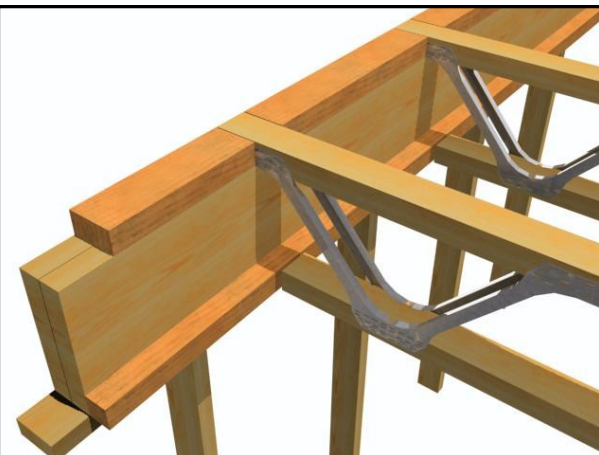

This detail illustrates a popular construction detail for supporting Posi-Joists™ at an external timber frame wall. This construction meets the thermal and air leakage requirements of Building Regulations Approved Document L1 & L2 (2006) provided that the floor edge is insulated by a material with a minimum R-value of 0.75m² K/W and that a bead of sealant is placed between the skirting board and the floor deck and that an effective air barrier is maintained within the floor zone by means of solid noggins or header joists. The construction provides lateral restraint to the wall provided that the connection is designed and detailed by the Building Designer.



Fire and Sound Resistance

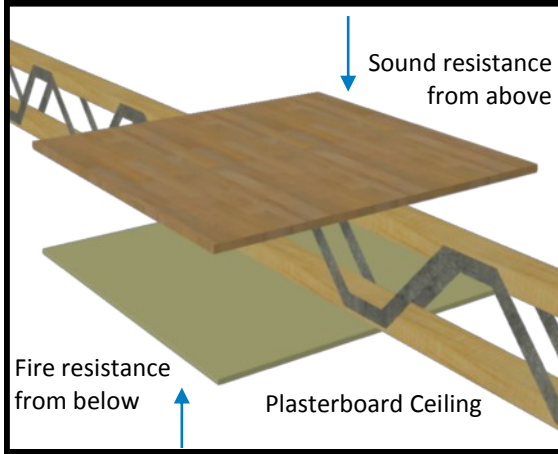

The requirement for fire resistance is normally 30 minutes for 1st and 2nd floors and this is provided almost entirely by the ceiling plasterboard. The responsibility for the plasterboard specification and fixing rests with the Building Designer.

Posi-Joist™ floors with a variety of floor build ups have been independently tested and certified for 30, 60 and 90 minutes fire resistance.

The following table provides details of Posi-Joist™ fire certification.

Time Period	Floor Build-up
30 Minutes	12.5mm British Gypsum Gyproc Wallboard with 5mm Plaster Skim and a 22mm Chipboard walking surface
30 Minutes	15mm British Gypsum Gyproc Wallboard with a 22mm Chipboard walking surface
30 Minutes with Down lighters	15mm British Gypsum Wallboard with a 22mm Chipboard walking surface
60 Minutes	Robust Detail E-FT-3— <i>See Page 12 for details</i>
90 Minutes	2 No. layers of 15mm Lafarge Firecheck plasterboard suspended on galvanised resilient bars fixed to the underside of the Posi-Joists™. 18mm Oriented Strand Board (OSB) subdeck.

The requirement for sound resistance of floors in England and Wales is that they should achieve a sound reduction of 40dB for airborne sound based on laboratory tests. **The following table provides details of Posi-Joist™ acoustic laboratory test results.**

Floor Build-up	Weighted Airborne Sound Reduction
253mm Posi-Joist™, 22mm Chipboard walking surface, 100mm Insulation	44
253mm Posi-Joist™, 22mm Chipboard walking surface. No insulation.	43
253mm Posi-Joist™, 18mm Ply walking surface, 100mm Insulation	41
223mm Posi-Joist™, 22mm Chipboard walking surface, 100mm Insulation	44
223mm Posi-Joist™, 22mm Chipboard walking surface. No insulation.	42

Note: 15mm Gypsum Wallboard ceiling used throughout, fixes to the Posi-Joists™ at 300mm centres using 38mm Gyproc drywall timber screws.

The World of Posi Technology

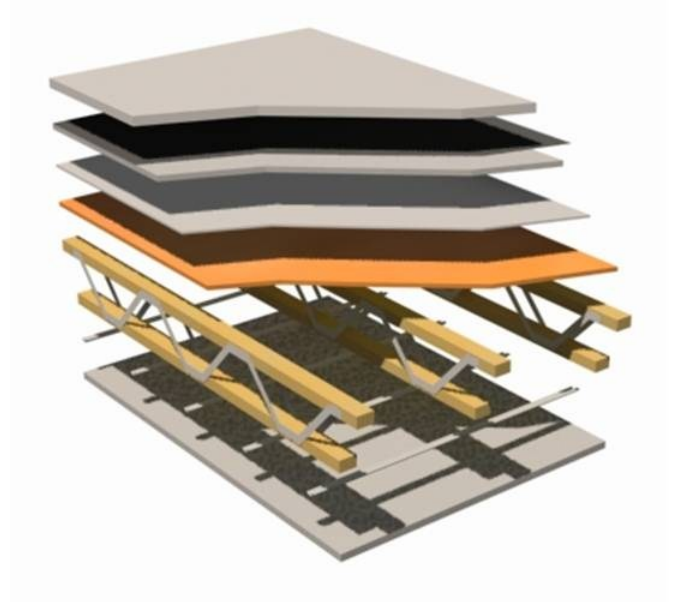
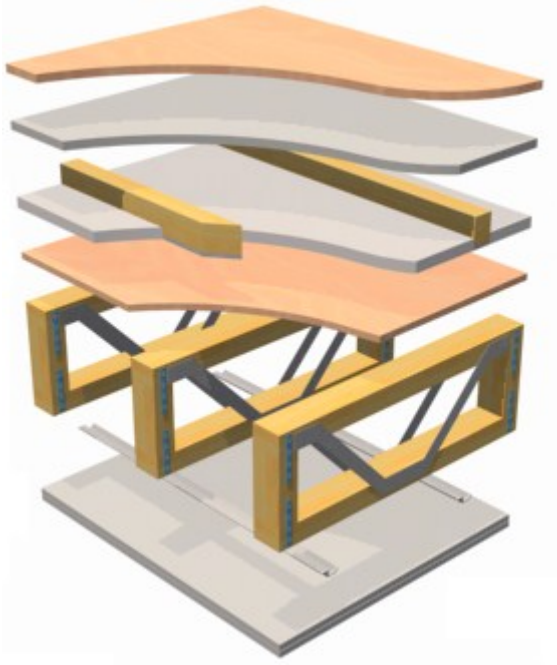

Separating Floor Applications

Separating Floor Applications



Separating floors need to meet enhanced requirements for fire resistance and sound resistance when compared to intermediate floors. Consequently the additional materials used to meet these requirements mean that the dead weight of a separating floor will be significantly greater than the notional dead weight of an intermediate or ground floor.

The period of fire resistance required is at least 60 minutes and this is provided almost entirely by the ceiling plasterboard. The responsibility for the plasterboard specification and fixing rests with the Building Designer.

Posi-Joist™ floors with a ceiling construction comprising of 2 No. layers of 12.5mm Gyproc Fireline plasterboard have successfully passed 60 minute fire testing.

Sound Resistance in Separating Floors

Separating floors need to achieve sound reductions of greater than 45dB for airborne sound and less than 62dB for impact sound and this should be demonstrated by pre-completion testing on site, or by adherence to Robust Details.

[Robust Detail E-FT-3 is the tested, proven detail for the use of Posi-Joists™ in separating floors in timber frame construction.](#)

The detail comprises of ceiling treatment CT2 made up of two layers of 15mm (nominal 12.5 kg/m²) fireline plasterboard fixed with 25mm and 42mm screws to resilient bars at 400mm centres. On top of an 18mm T&G Subdeck, a resilient composite deep batten system with a minimum depth of 70mm is placed with 25mm (10-33kg/m²) insulation placed between the battens. On these battens a 19mm Gypsum based board (nominal 13.5kg/m²) is placed with a final deck of 18mm (min) T&G flooring board on top.

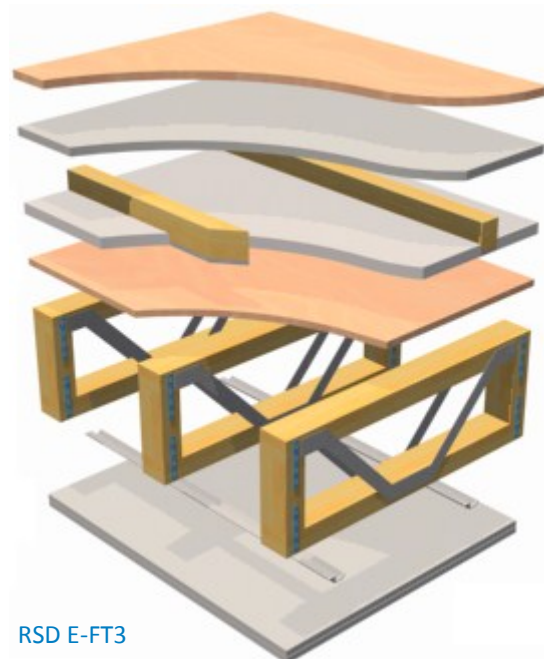

Working in conjunction with our partners Prestoplan, MiTek ensured that Posi-Joist™ was the first metal web joist system in the UK to obtain a Robust Detail for the resistance to the passage of sound.



Separating Floor Applications



An alternative separating floor detail for Posi-Joist™ is the **Screedflo dB** system.

With a build up of only 74mm from sub-deck to finished surface, a Screedflo dB floor can be considerably shallower than some common construction details. This often allows the removal of a course of brickwork at each level.

Ideal for under floor heating systems, services may be run in ducting through the screed, or through the open web zone of the Posi-Joist™. Unlike other joist systems there is no requirement to add a service void below the standard ceiling—once more conserving the height of the building.

The Screedflo dB system should only be installed once the roof and windows are in place and the building is weather tight. Ideally, any services which penetrate the floor zone should also be installed to allow them to be isolated acoustically. The screed takes 24 hours to cure sufficiently to be walked on. During this period, windows should be kept shut to prevent too rapid drying. After 24 hours, some windows should be opened to provide ventilation. The screed will then dry at a rate of nearly 2mm per day, a typical floor will fully dry over a 3 week period. Floor finishes, including tiles, can then be applied.

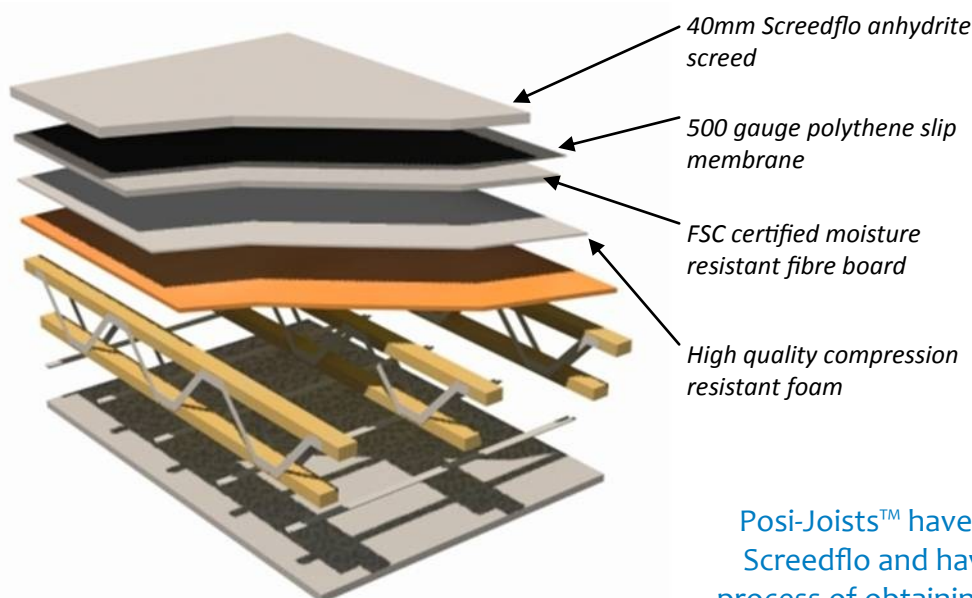

Posi-Joists™ have undergone long term testing with Screedflo and have obtained a TRADA Q Mark. The process of obtaining a Robust Detail for this method of construction is under way.

When an acceptable Posi-Joist™ design has been achieved with respect to structural, fire and sound requirements it should be noted that the performance of any separating floor can be compromised by poor detailing and workmanship. In particular care should be taken to isolate floor finishes from wall finishes since friction between ceiling lining, coving and dry-lining can result in impact sound transfer from the upper dwelling to the lower dwelling.



Masonry Bearing Details

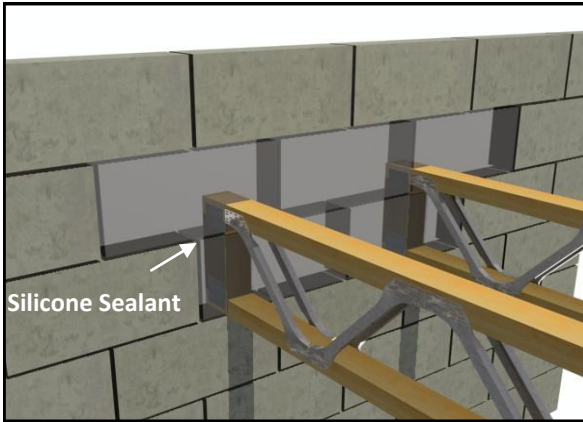

Figure 1: Bottom Chord Built Into Masonry
Block work to continue between Posi-Joists™ to provide restraint. **Note: This is not allowed on single skin external walls**

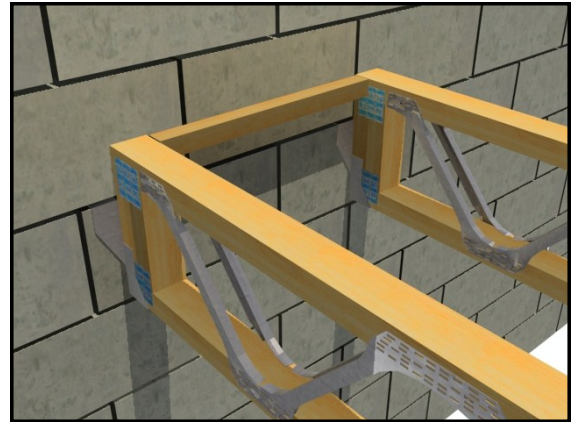

Figure 2: Masonry Hanger Detail. Top Chord restraint fixed between Posi-Joists™. (Choose correct hanger for load, bearing width and coursework level of hanger bearing flange.)

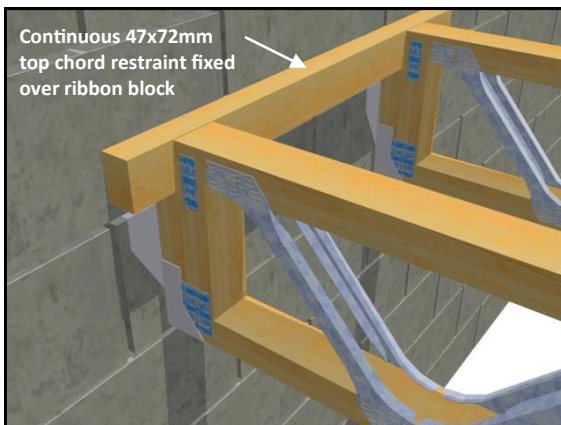

Figure 3: Masonry Hanger Detail. With continuous ledger. Minimum bearing determined by design (choose correct hanger for load, bearing width and coursework level of hanger bearing flange).

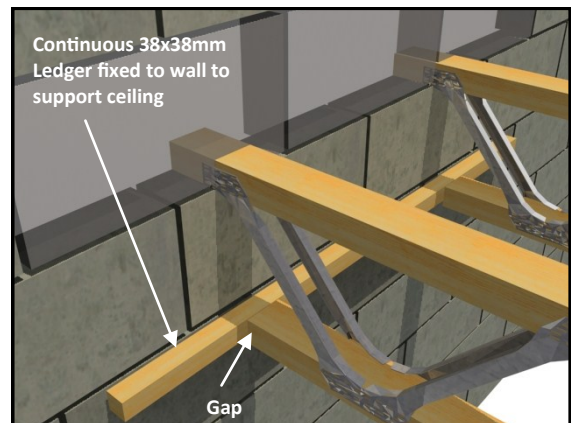

Figure 4: Top Chord Built into Masonry

Note: This is not allowed on single skin external walls

Soil Pipe Corner Details

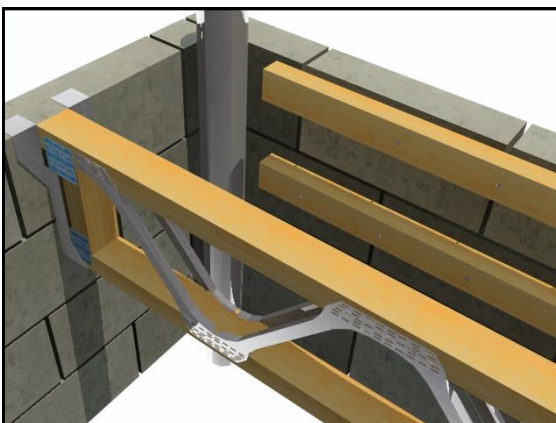

Figure 5: Fixing Around Soil Vent Pipe Using Bearers
38x38 bearers fixed directly to the wall to pick up both floor and ceiling.

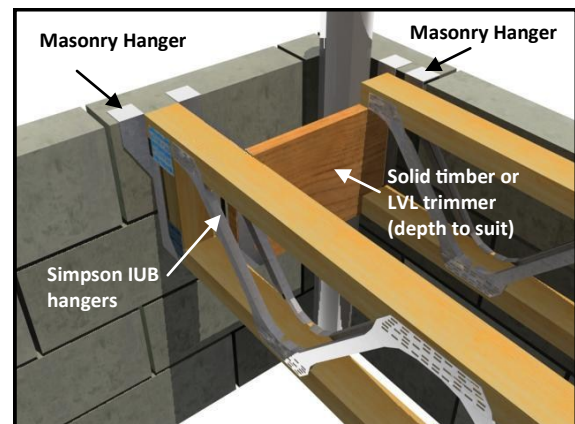

Figure 6: Fixing Around Soil Vent Pipe Using Trimmer
See Robust Detail E-FT-3 (11) for treatment of service void penetrating the separating floor.



Timber Frame Details

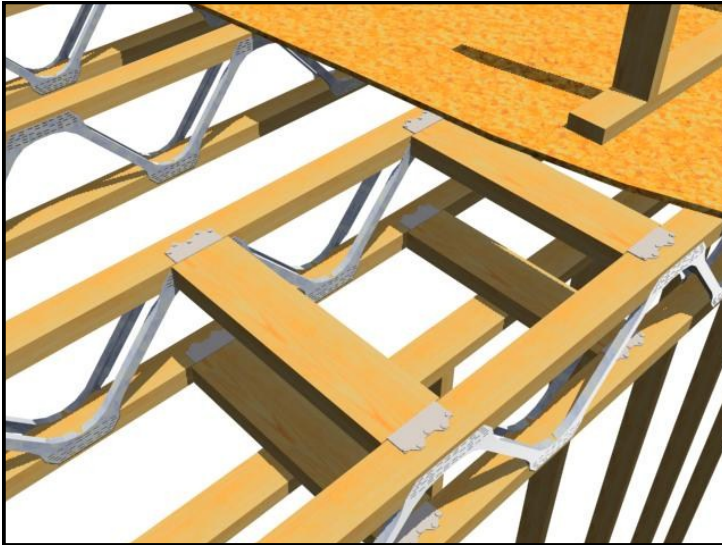

Figure 7: Non-load bearing partitions parallel to Posi-Joists™

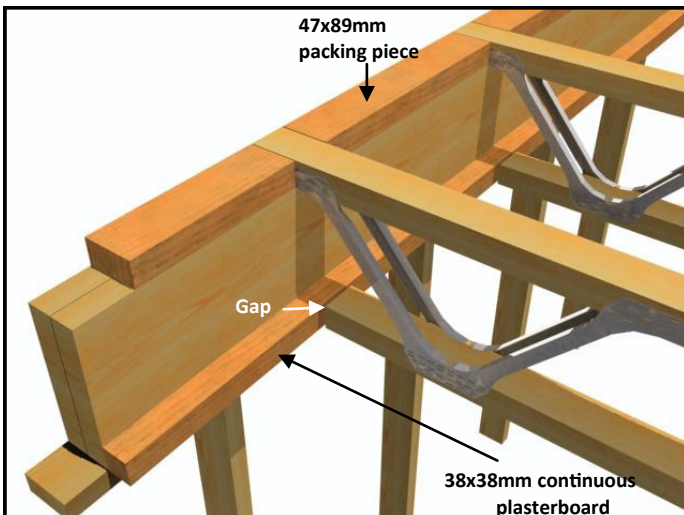

Figure 9: Top Chord Fixing to Timber Frame

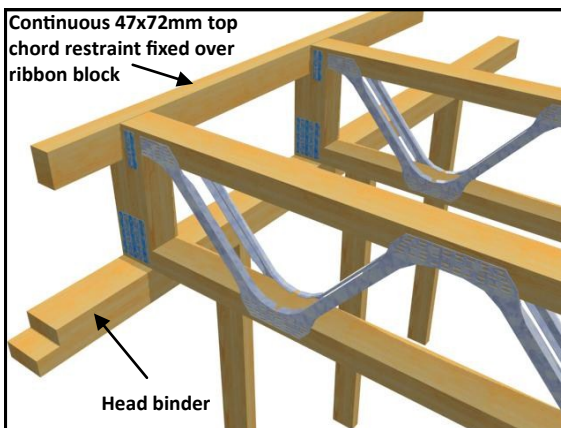

Figure 10: Bottom Chord Fixing to Timber Frame (with continuous restraint)

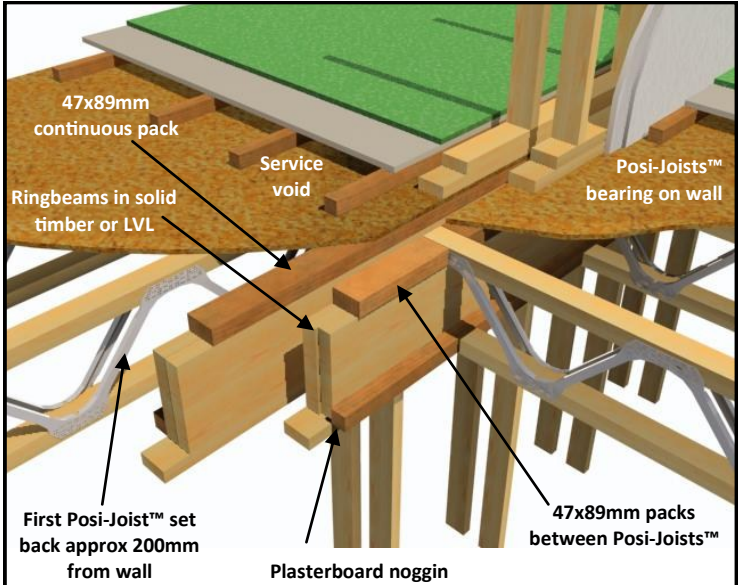

Figure 8: Timber Frame Party Wall (with service void)

Floor comprising: 22mm T&G chipboard on 19mm plasterboard and plank on 47x75mm resilient floor batten at 400mm centres on 18mm T&G chipboard. All T&G edges glued.

Ceiling (not shown) comprising: 2 layers 15mm Gyproc Fireline board on 25mm resilient bars at 400mm centres. First layer fixed with 25mm Gyproc screws at 230mm centres. Second layer fixed with 42mm gyproc screws at 230mm centres. Staggered with first layer. Lay Fireline board in echelon pattern with staggered joints. Ceiling boards and fixings must not penetrate or touch joists

Bead of sealant applied to floor deck prior to fixing 19mm plasterboard plank.

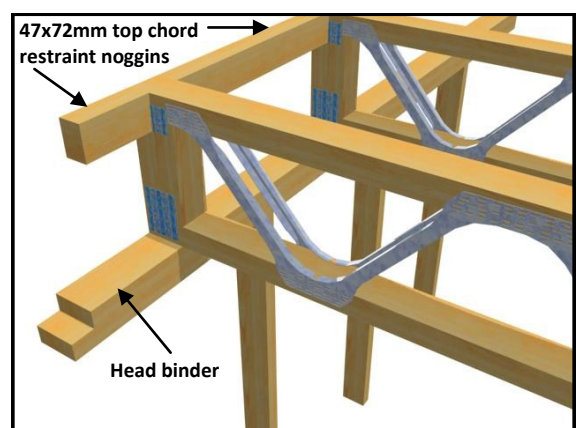
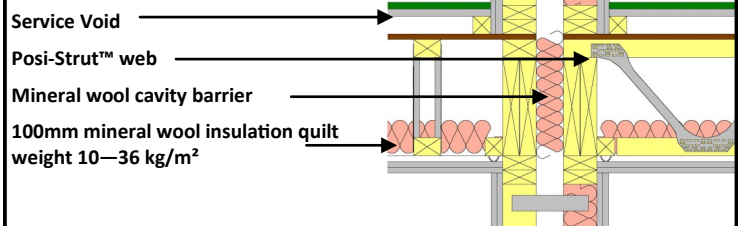

Figure 11: Bottom Chord Fixing to Timber Frame (with restraint noggins)



Timber Frame Details (Continued)

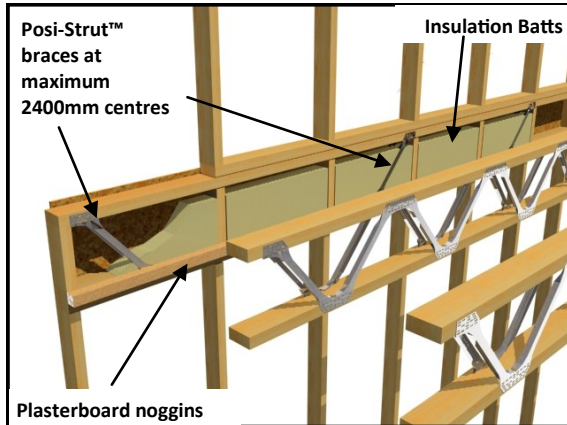

Figure 12: Edge Closure Detail Using MiTek F-Frame
Where there are larger openings in the upper storey wall which cause a concentrated load a suitable timber vertical should be inserted under the point load to transfer it down to the wall below.

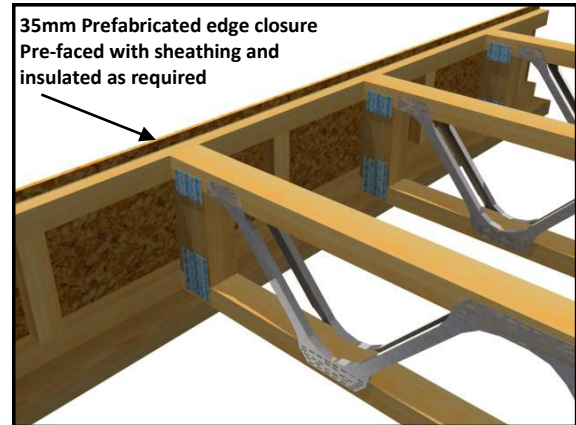

Figure 13: Edge Closure Detail
Posi-Joist™ requires a minimum 50mm bearing

Internal Bearing Details

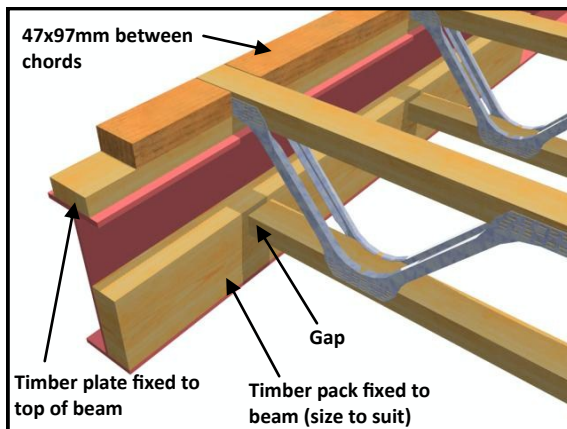

Figure 14: Top Chord Fixing to Steel Downstand Beam

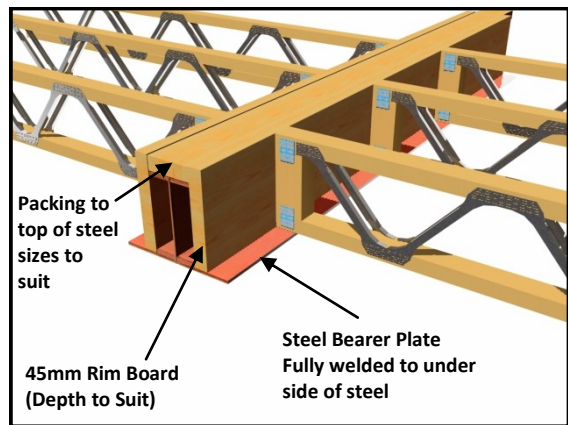

Figure 15: Steel Beam Within Floor Zone
Posi-Joist™ bottom chord to be notched over steel bearer plate without interfering with connector plate

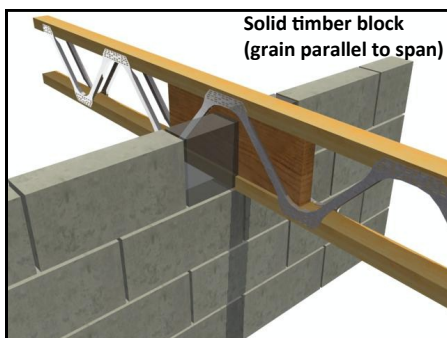

Figure 16: Continuous Posi-Joist™ Through Masonry

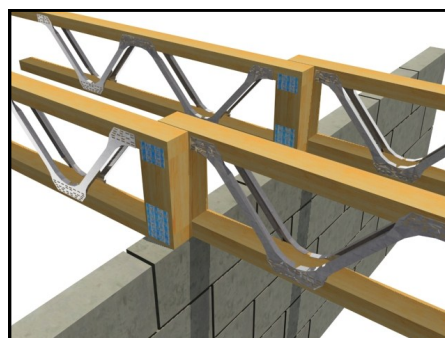

Figure 17: Shared Internal Bearing

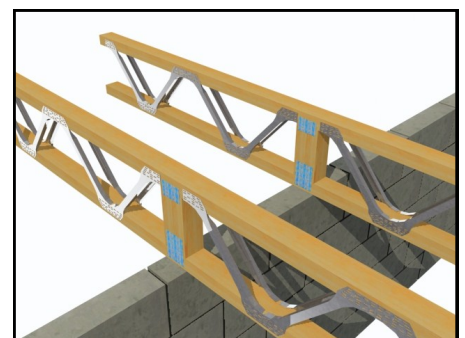
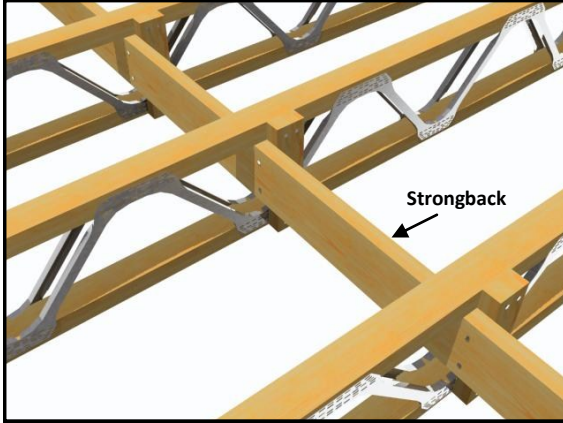

Figure 18: Internal Bearing

Note: This is not allowed on external walls or fire walls.



Strongback Bracing Details—Fix at Maximum 4.0 Metre Centres



Position strongback tight to the under side of the top chord. As close as possible to centre of joist for maximum effect.

Insert strongback through Posi-Joists™ before fixing joists. It may not be possible after the joists have been fixed.

Figure 19: Strongback Detail—Posi-Joists™ with Strongback blocks 38x75mm (min) blocks twice nailed to top and bottom members and twice nailed to brace using 3.1x75mm long galvanised wire nails.

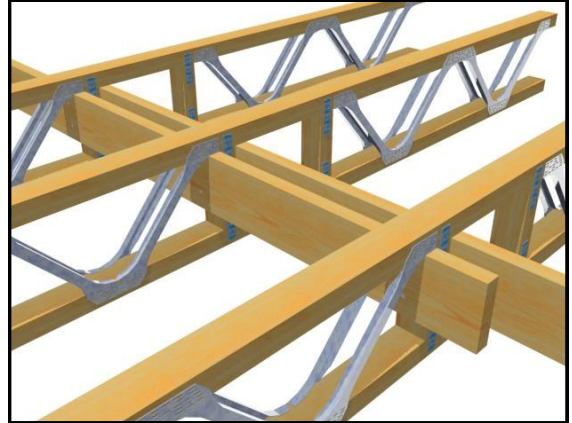
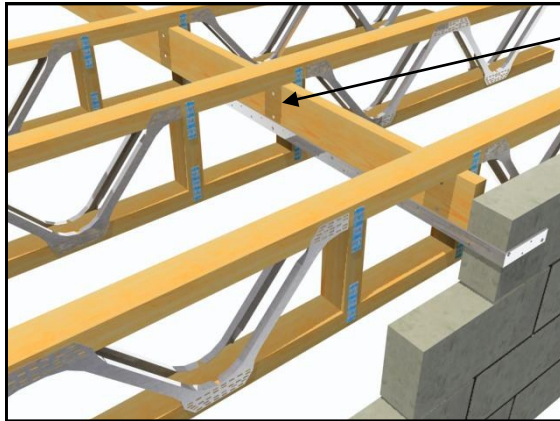

Figure 20: Strongback Detail—Posi-Joists™ with built in verticals Posi-Joists™ can be designed with built in timber verticals for strongback fixing. The strongback is twice nailed as above.



Twice nailed to brace using 3.1x75mm long galvanised wire nails.

Figure 21: Horizontal Restraint Straps Fixed Directly to Strongback Strap fixed with a minimum of four fixings of which at least one is to be over the third joist.

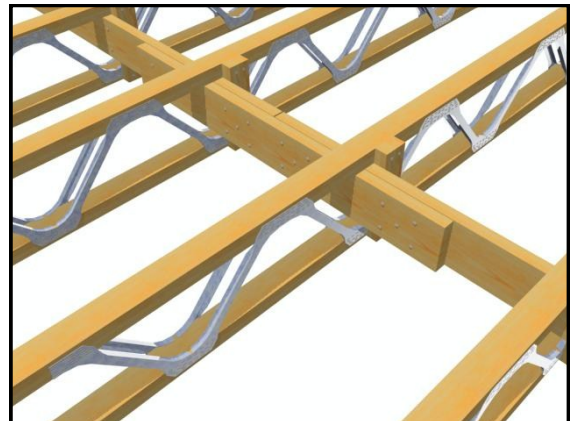
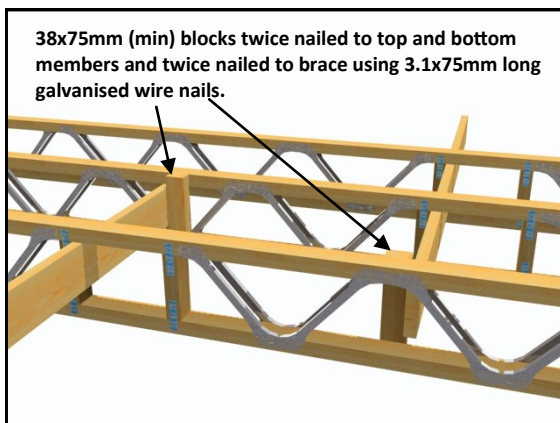

Figure 22: Strongback Splice

1200mm long splice fixed with 10 no 3.1x100mm long galvanised wire nails each side of splice, nailed through and clenched over on far side.



38x75mm (min) blocks twice nailed to top and bottom members and twice nailed to brace using 3.1x75mm long galvanised wire nails.

Figure 23: Strongback Detail for Change of Span

Strongback Size Chart

Web Size	Min. Strongback Section
PS8 & PS9	35 x 97 mm
PS10(N)	35 x 120 mm
PS12(N)	35 x 145 mm
PS14(N) & PS16(N)	Min 35 x 145 mm *

* The deeper the strongback, the stiffer the floor



Stairwell Details

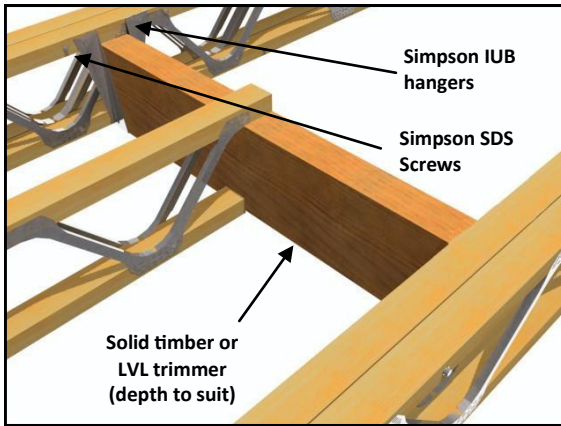

Figure 24: Staircase Opening
Trimmer to be notched over the bottom flange of the hanger

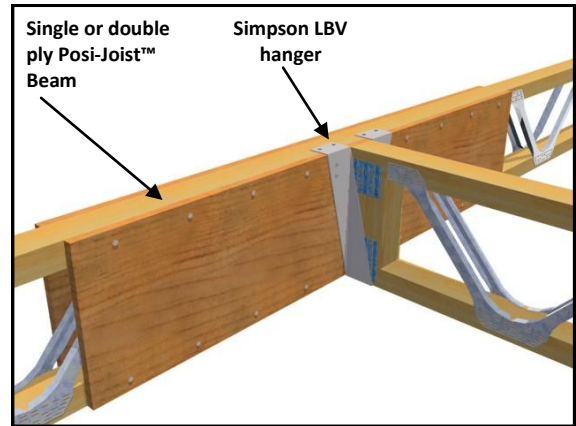

Figure 25: Posi-Joist™ to Posi-Joist™ Connection
Plywood nailed to both faces of trimmer beam. Ply/nailing as specified by design

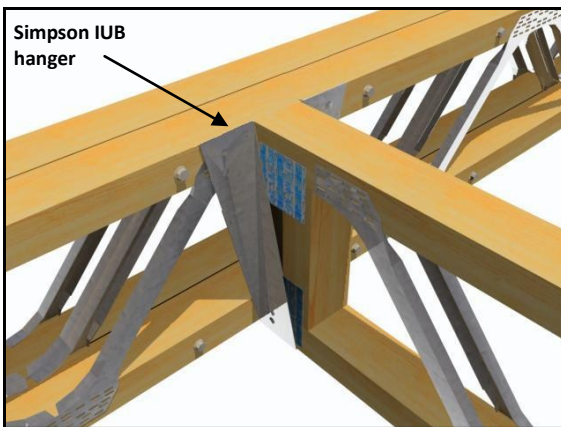

Figure 26: Posi-Joist™ to Posi-Joist™ Connection
Bottom member of Posi-Joist™ to be notched over the flange of the hanger

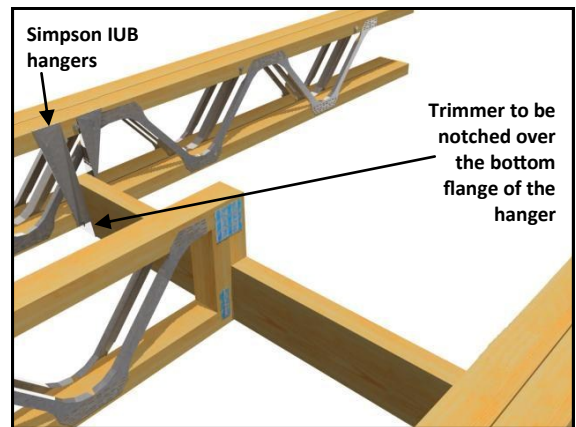

Figure 27: Narrow Opening Detail

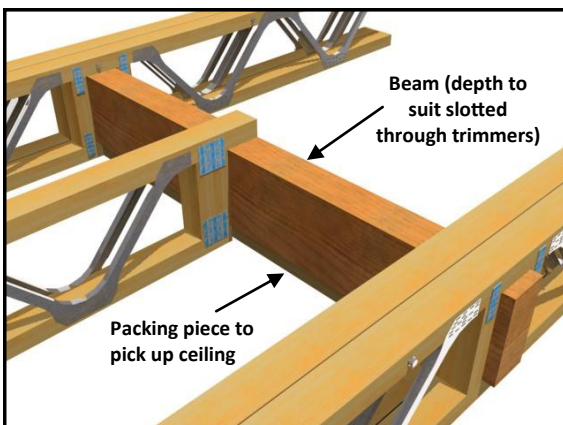
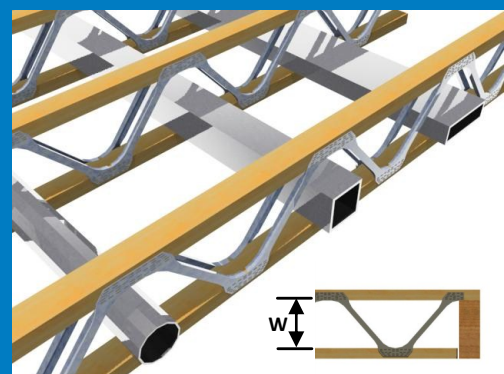

Figure 28: Narrow Opening Detail

Maximum Duct Sizes



Posi-Strut Size	W	Circle Dia	Square	Rectangle Depth						
				50	75	100	125	150	175	200
				Rectangle Width						
PS8	108	105	95	270	180	90	-	-	-	-
PS9N	134	130	115	310	240	180	100	-	-	-
PS10N	159	150	135	320	270	210	160	80	-	-
PS12N	210	190	155	350	310	260	210	160	110	70



Internal Load Bearing Walls

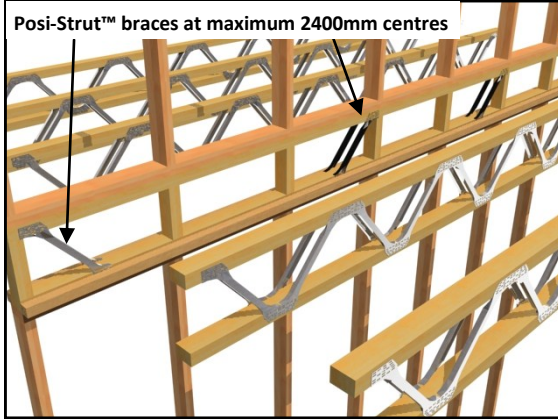

Figure 29: Posi-Joists™ Parallel to Internal Load Bearing Wall Using MiTek F-Frame

Where there are larger openings in the upper storey wall which cause a concentrated load a suitable timber vertical should be inserted under the point load to transfer it down to the wall below. Plasterboard noggins attached as shown.

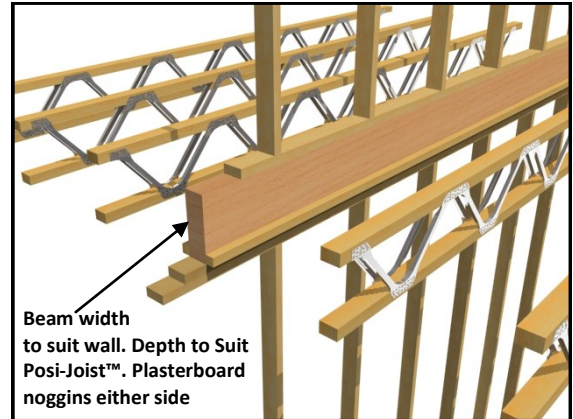

Figure 30: Posi-Joists™ Parallel to Internal Load Bearing Wall

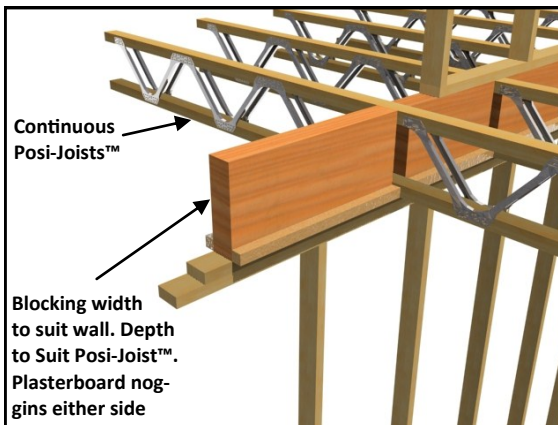

Figure 31: Continuous Posi-Joists™ Perpendicular to Internal Load Bearing Wall

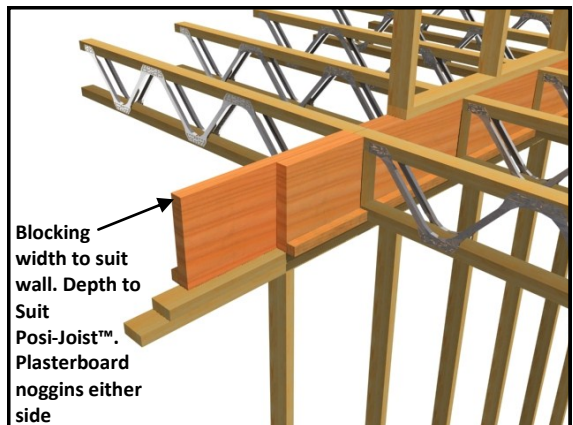

Figure 32: Butting Posi-Joists™ Perpendicular to Internal Load Bearing Wall

Where this detail is used in a Posi-Joist™ cassette construction an additional blocking brace should be included to secure the blocks.

Posi-Joist™ Span Information



Indicative Span Information

If you are a member of the iStructE or RIBA you can [download](#) a free version of the 20/20 Posi-Joist design software from the MiTek website to allow you to accurately specify Posi-Joist designs.

The following indicative table as to be used as a typical guide to the clear spanning capabilities of Posi-Joists™. Please consult a licensed Posi-Joist manufacturer prior to specifying Posi-Joist sizes to discuss the loading conditions for the entire floor.

Click [here](#) to download the latest list of licensed Posi-Joist manufacturers.



	600mm Centres	
Overall Depth of Posi-Joist™	72mm Joist Width	97mm Joist Width
202mm (PS8 Posi-Joist™)	4300mm	4800mm
225mm (PS9(N) Posi-Joist™)	4750mm	5100mm
253mm (PS10(N) Posi-Joist™)	5100mm	5600mm
304mm (PS12(N) Posi-Joist™)	5800mm	6200mm

These are indicative Posi-Joist™ clear spanning capabilities based upon domestic floor loads including a partition load. Posi-Joists™ can span greater clear spans by reducing the joist centres, increasing the joist width; and by increasing the size of the strongback brace. Consult a [licensed Posi-Joist manufacturer](#) to establish the correct Posi-Joist™ depth to specify for your floor.

Free Posi-Joist™
design Software



RIBA



Free to iStructE and RIBA Members





Storage on site should be for a limited period of time prior to erection of the Posi-Joists™.

Posi-Joists™ should either be stored vertically or on the flat. If stored vertically there should be intermediate bearers at node points not within the bay of a joist, as shown below. If stored in a flat position, sufficient bearings should be provided to prevent excessive lateral bending.

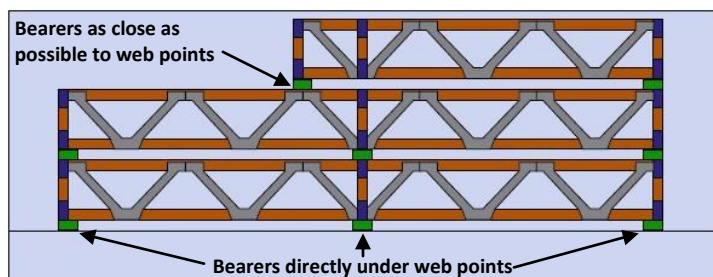

It is recommended that completed Posi-Joists™ be strapped together and wrapped in a waterproof protective covering to protect them from short term exposure to inclement weather.

Special precautions should be taken when stacking top chord supported floor cassettes to prevent the stack lozenging in storage. Additional bracing to the ends of the stack should be fixed to stop lateral movement. Care should be taken when handling the Posi-Joists™ to avoid bending, twisting or dropping.

When loading/offloading with a crane, slings should always be attached to the timber chords or the cassette lifting points, and not to the metal webs to avoid buckling. Slings should be attached at panel points closest to the quarter points of the Posi-Joists™ as shown below.

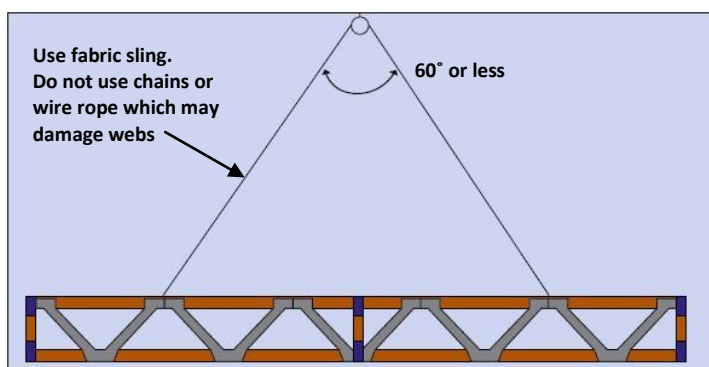

Set Out & Placement

Posi-Joists™ are generally placed perpendicular to the load bearing supporting walls and should be located so that the distance between them does not exceed the design spacing – always consult the Posi-Joist™ layout drawing and proceed with erection of the floors as follows:-

1- Plan the erection sequence and place the Posi-Joists™ close to where they are required, only distribute a sufficient number of joists around the building which can be erected in a reasonable period of time. Posi-Joists™ should be protected from inclement weather and stored as noted above.

2- Before lifting the Posi-Joists™ to scaffold level do make sure the correct end of the joist is at the appropriate support as the end details may be different. Also be aware of any internal supports which are being used and that the special internal bearing detail for the joist is in the correct position.

3- If the Posi-Joists™ are supported over more than 2 supports make sure all the supports are the same level and when the joists are lifted into place they rest on all of the supports.

4- If the Posi-Joists™ are supported on masonry hangers, make sure they are the ones specified and are firmly anchored in place and that the masonry is cured in line with hanger requirements. Joists should have a full bearing with no more than a 5mm gap between the end of the joist and the face of the hanger. Masonry hangers with a cavity return and integral strap provide lateral restraint to wall heads.

5- Make sure the Posi-Joists™ are erected the correct way around, the joists will normally be marked "TOP" and the first metal web will normally start at the top of the Posi-Joists.™



6- The Posi-Joists™ are positioned to coincide with the deck joints, the first of which is normally 1210mm away from the wall face in masonry construction or 1200mm from the cavity face in Timber Frame construction when the deck extends to the cavity face; when the joists are spaced at 400 or 600mm centres. There is normally a 10mm perimeter gap between the face of the deck and the face of the wall in masonry construction to allow for potential expansion of the deck. The board material is normally 1200 x 2400mm, the long dimension spanning at 90° to the joist span. The remaining joists are normally spaced on a grid of 400, or 600mm centres, on occasion at 480mm centres.

7- When the deck is set out from the face of the wall it is normal to have the first joist edge 50mm from the face of the wall where in Timber Frame construction with the deck set out from the cavity face it is normal to not have a joist close to a wall, the deck and plasterboard being supported on a timber ledger nailed to the frame. Carefully follow the layout drawing and the wall/joist interface details provided by the Building Designer, in particular in Timber Frame where the joist centres and the stud centres may have to line through.

8- The penultimate Posi-Joist™ in the run is set out on the standard module and the last joist is positioned similar to the first in the run.

9- Posi-Joist™ stair trimmer joists and trimmers will be required around stair openings which may be on the main joist grid or usually off the grid. Set these joists out strictly in accordance with the architectural and Posi-Joist™ layout drawing and fix the trimmer joist to the stair trimmer and the trimmed joists to the trimmer joist with the metal hangers specified making sure that any 2 ply joists are adequately connected together as detailed.

10- To temporary brace and space the Posi-Joists™ which have been laid in position fix a piece of 22 x 97 bracing to the top of the joists at their ends and mid span or around 2.4m centres on spans longer than 4.8m.

11- Install the strongback bracing as detailed, the strongback is always installed on edge not on flat and must be fixed to the integral strongback blocks or noggin pieces nailed to the face of the joist. The strongback must be fixed tight to the underside of the top chord. Due to the width of the Posi-Joist™ chords and the additional stiffness installed in the floor due to the strongback bracing, it will not normally be necessary to employ any temporary diagonal bracing.

12- When all the Posi-Joists™ have been positioned and fixed in place, the partition noggins, perimeter noggins, rim boards, when required can be installed, and in the case of masonry construction the steel lateral restraint straps should be fixed in place at no greater than 2m centres and should extend over 3 joists.

13- The floor carcass is now ready to receive the decking material and acoustic material where required.

14- The maximum load of sheet materials temporary stored on the Posi-Joists™ is 250kg/m² and should not be greater than 300mm deep. This equates to 16 sheets of 18mm chipboard, 13 sheets of 22mm chipboard or 20 sheets of 15mm plasterboard. Where the sheets are stacked by hand they should span lengthways across the joists, (Fig 1), when lifted mechanically they should be seated on 5 bearers the width of which are 600mm longer than the width of the board. (Figs 2 & 3).

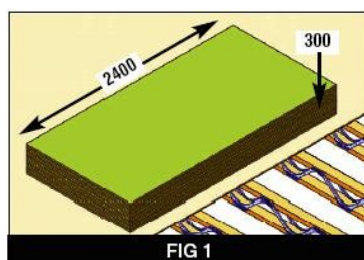

FIG 1

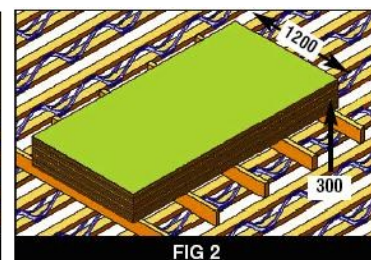

FIG 2

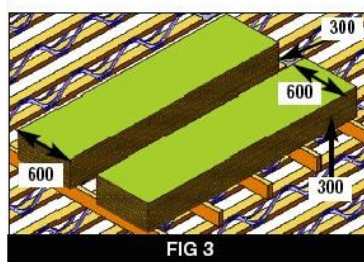

FIG 3

DOs and DON'Ts



DON'T
Drill holes in the
timber chords



DON'T
Cut notches in
the timber

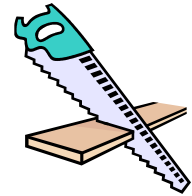

DON'T
Cut through the
timber chords



DON'T
Cut or remove
the metal webs

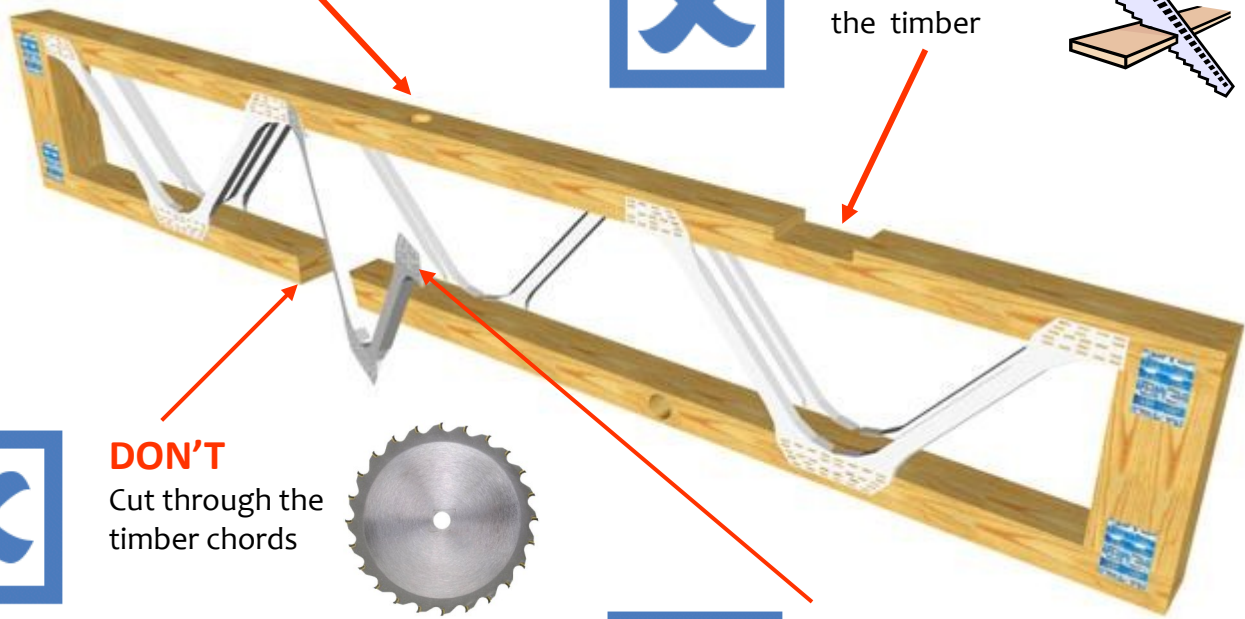

DO
Store as shown in handling
and storage section



DO
Use the open web feature
for services



DO
Lift the Posi-Joists™ in a
vertical position



DO
Protect Posi-Joists™ from
inclement weather

The World of Posi Technology



Roof Applications



Posi-Rafter Standard Details

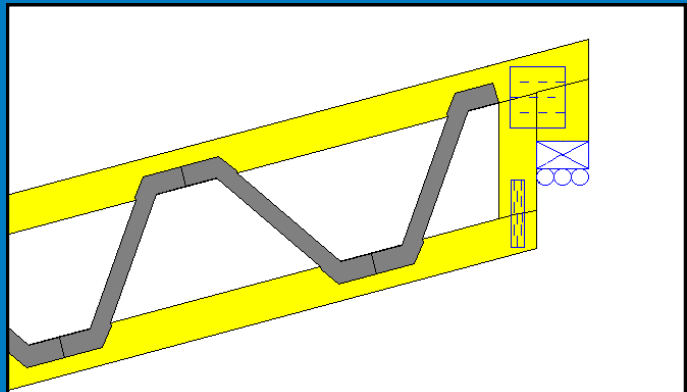
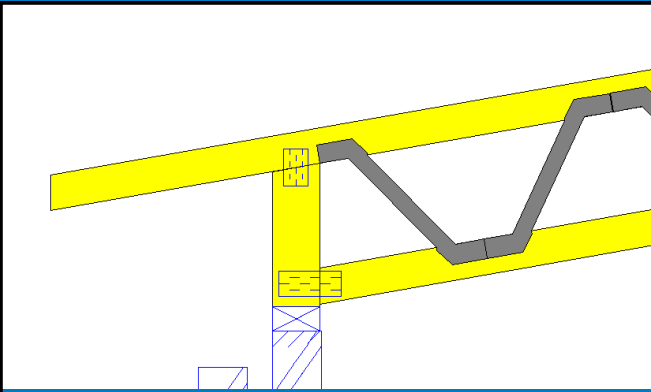
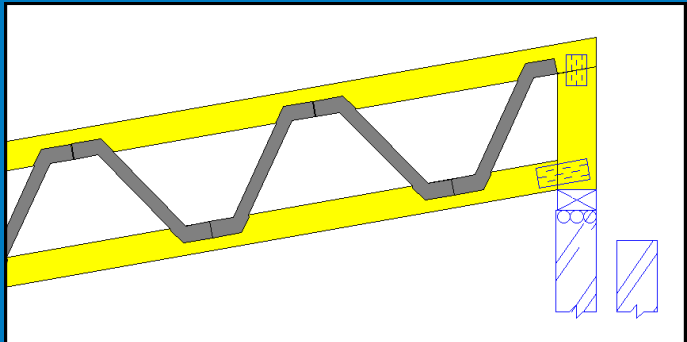
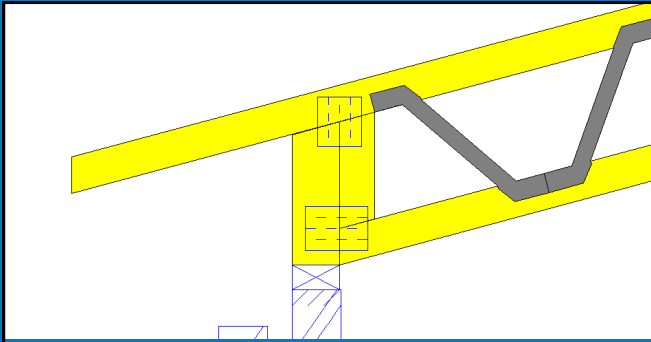
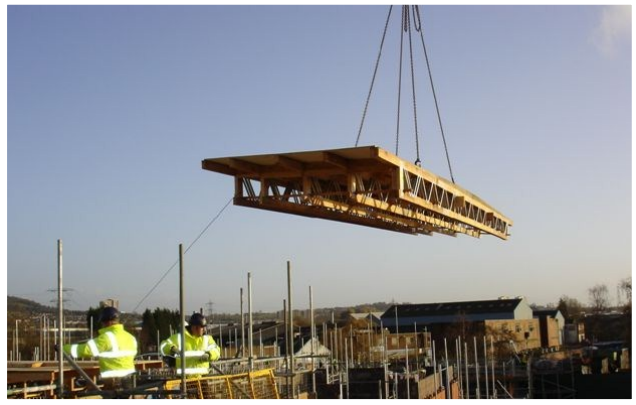

Recommended eaves and apex details for use with Posi-Rafters. All of these details are available for use by trained Posi-Rafter designers in the MiTek 20/20 design software.

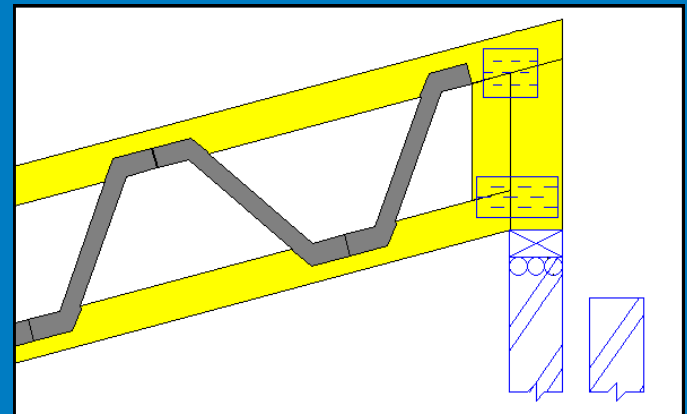

The X-Rafter



This exciting new roofing system provides a flexible room in the roof solution capable of providing the thermal performance that will increasingly be required by the planned revisions to Part L of the Building Regulations. The MiTek Posi-Strut™ technology ensures that the roof panels are lightweight and easy to install. The system arrives on site, felted and counter battened ensuring that the roof is watertight in a short period of time.

The environmental benefits include the low U-Values that the system can achieve of 0.17 W/m²K; timber's impeccable sustainability credentials; and the design of the loft as a "cold area" thus further reducing the energy consumption of the dwelling.

<p><i>Based on a MiTek Posi-Joist™ floor, the working platform for the Posi X-Rafter roof is assured with the use of laser levels.</i></p>	<p><i>Flat top spandrels are positioned incorporating location slots for the ceiling cassettes. The spandrel panels are stubbed as required by the roof dimensions.</i></p>	<p><i>The structural ceiling cassette incorporating the roof support purlins are located. Timber frame dwarf walls are positioned to provide a second Posi X-Rafter support.</i></p>
<p><i>Apex spandrel panels are positioned using the structural ceiling as a safe working platform.</i></p>	<p><i>Posi X-Rafter cassettes are positioned and fastened to the supports. Posi X-Rafters are insulated at the point of manufacture and are pre-felted and battened.</i></p>	<p><i>The underside of the Posi X-Rafter cassette is clad with OSB in the room area only.</i></p>
<p><i>Dormer windows are easily catered for by the system.</i></p>	<p><i>Insulation material costs are lower than competitive systems as the loft area is a cold area, reducing the energy consumption of the dwelling.</i></p>	<p><i>Call us for information on how to become a licensed MiTek Posi X-Rafter manufacturer.</i></p>



Ideal for use in narrow fronted gable to gable housing, the X-Rafter system starts with flat top structural gable panels, fixed to offsite manufactured Posi-Joist™ floor cassettes.

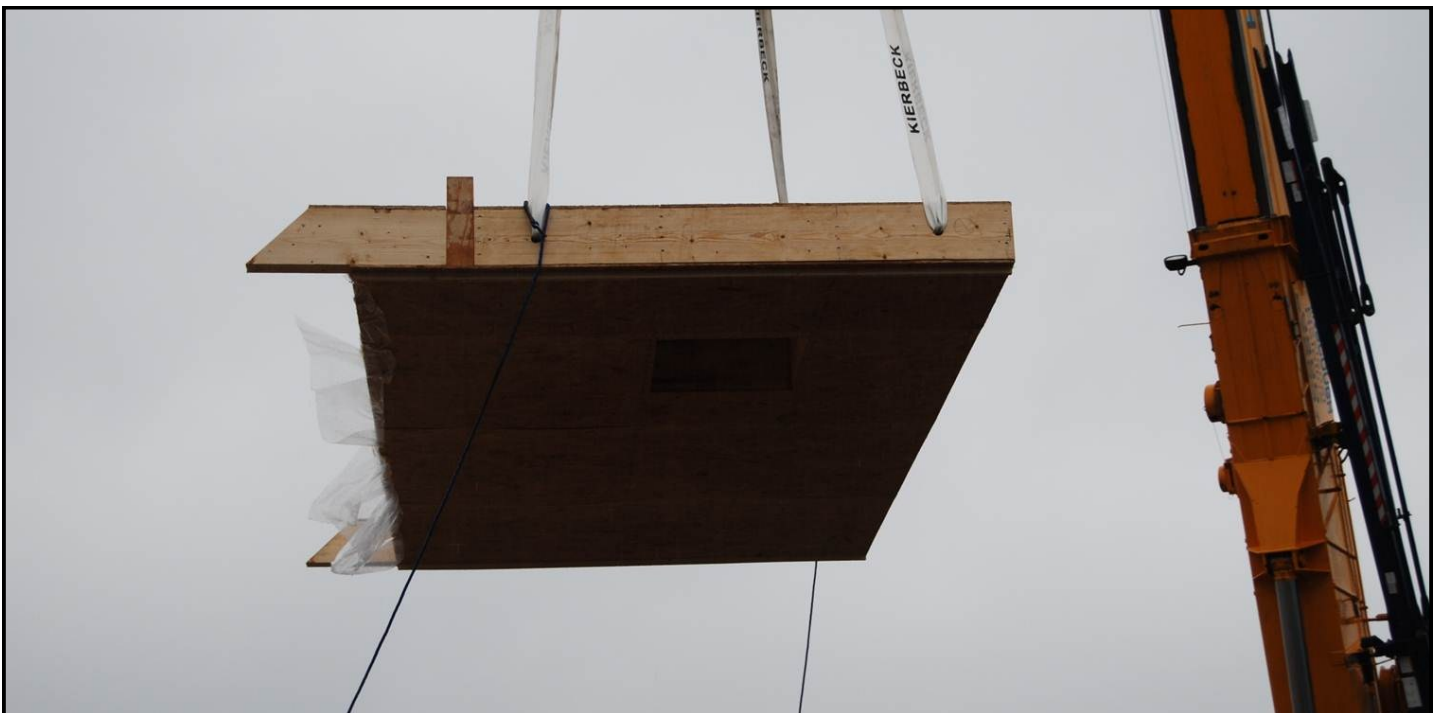

Spanning between the two structural gable panels, the next element of the X-Rafter system to be positioned is a pre-fabricated structural ceiling cassette with up-stand beams to provide the support for the X-Rafter roof cassettes.



Pre-Insulated, felted and counter battened offsite, the X-Rafter cassettes are craned into position.



The Posi-Joist cassette floor and the structural ceiling cassettes form two safe working platforms providing that the appropriate harnessing is worn by the installation team.



The apex spandrels are lowered into position to complete the cold roof space above the pre-insulated ceiling panels.



Wind and water tight in hours not days, the X-Rafter combines health and safety benefits with all the benefits of offsite timber engineering manufacture. Contact MiTek for further information.

Posi-Attic Trusses



Maximise Your Living Space with the MiTek Posi-Attic



Combining the solid feel of a MiTek Posi-Joist™ with the benefits of a conventional attic truss, the MiTek Posi-Attic enables you to span much larger spans than conventional systems. The strength of the Posi-Joist™ floor provides increased living space within the attic, delivering maximum value to the home owner.

The Posi-Joist™ floor is ideal for easy installation of Heat Recovery Ventilation Systems, soil pipes and the increasingly diverse range of services installed in modern homes



Picture reproduced with thanks to Pasquills



Posi-Joist™ Roof Cassettes



Picture reproduced with thanks to Donaldson McConnell (Midlands) Ltd

By rotating the timber flanges through 90° so that the timber is on edge rather than on flat, the Posi-Joist™ becomes much stiffer and the span capabilities are increased. The subsequent resulting instability of the “on-edge” joist can be removed by specifying that the Posi-Joists™ are pre-fabricated into cassettes for ease of installation.

The World of Posi Technology



Wall Applications





300mm Posi-Stud

- Posi-Stud filled with Mineral Wool*
- inner lining of plasterboard*
- vapour control layer*
- OSB Sheathing*
- 2 No. 150mm layers of 35 lambda Mineral Wool*
- Battened service zone*
- OSB Sheathing*
- High Performance Breather Membrane*
- drained and vented 50mm cavity*
- outer leaf of masonry*

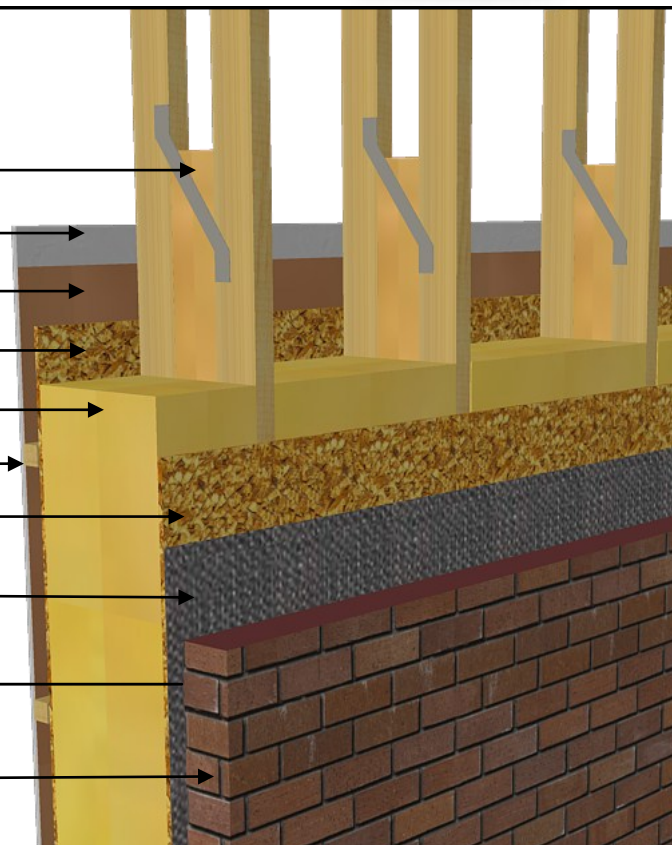

Calculated U-Value: 0.12 W/m²K

200mm Posi-Stud

- Posi-Stud filled with Mineral wool*
- inner lining of plasterboard*
- vapour control layer*
- OSB Sheathing*
- Battened service zone*
- OSB Sheathing*
- 2 No. 100mm layers of 35 lambda Mineral Wool*
- High Performance Breather Membrane*
- drained and vented 50mm cavity*
- outer leaf of masonry*

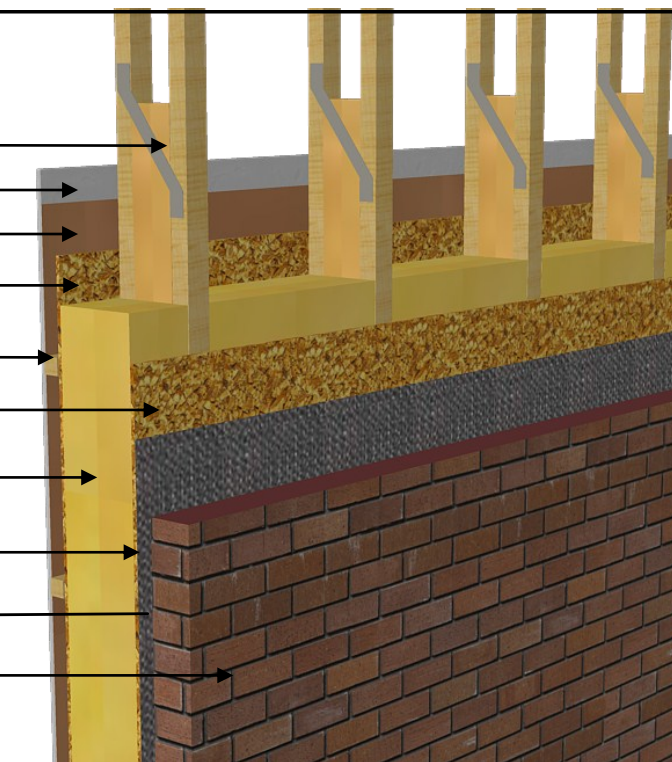

Calculated U-Value: 0.17 W/m²K

Sample Posi-Stud Details

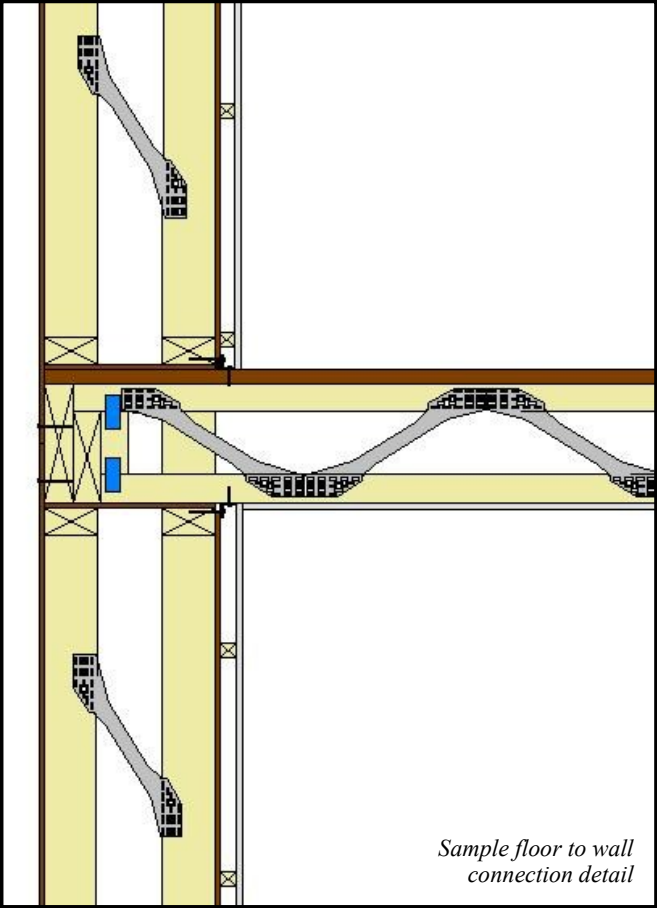

Sample floor to wall connection detail

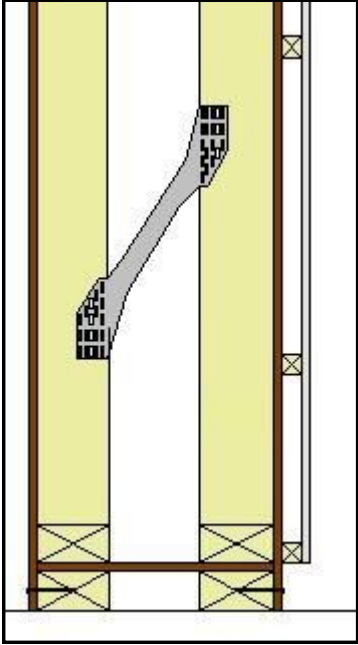

Sample sole plate connection detail

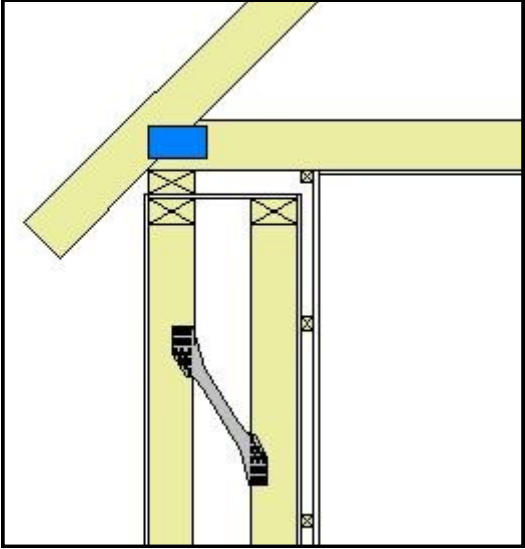

Sample wall to roof connection detail

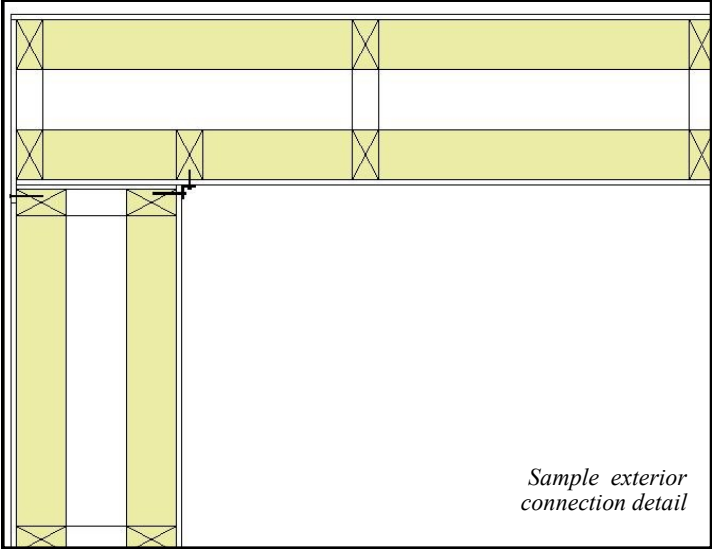

Sample exterior connection detail

Posi-Stud Photographs



Picture reproduced with thanks to O'Reilly Timber Frame

Posi-Stud Photographs



MiTek Industries Ltd

Grazebrook Industrial Park
Peartree Lane
Dudley
DY2 0XW

t: 01384 451400

f: 01384 451411

www.mitek.co.uk